

pecron

# E3600 LFP

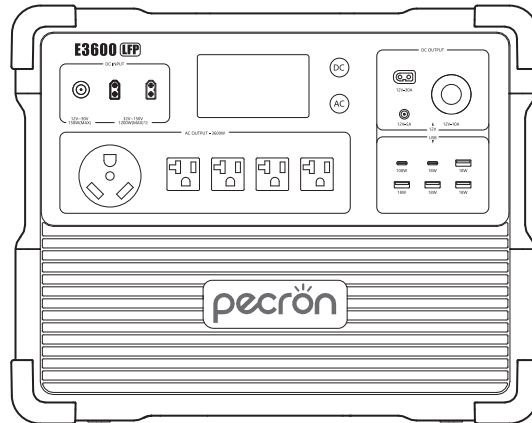

## USER MANUAL

Please read the user manual thoroughly before using

[support@pecron.com](mailto:support@pecron.com)

# FUNCTION INTRODUCTION

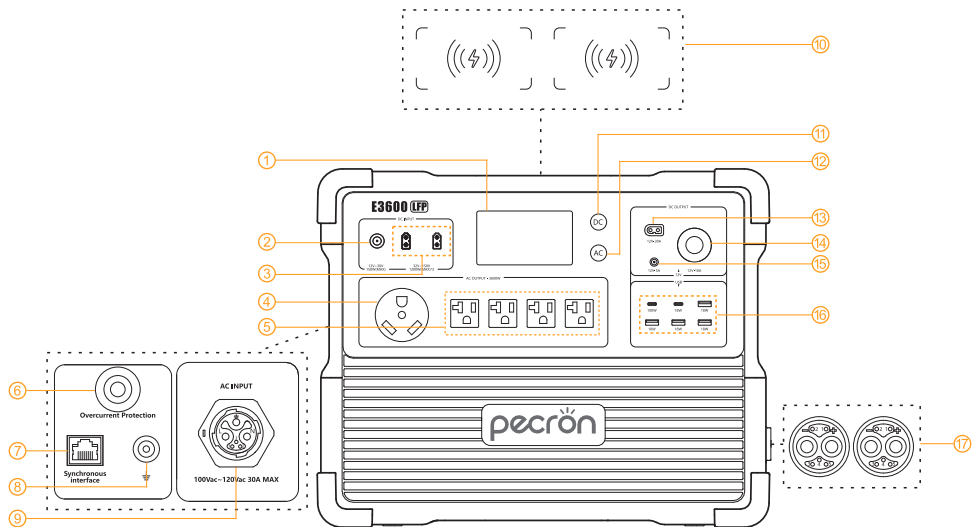







- |                              |                               |                             |
|------------------------------|-------------------------------|-----------------------------|
| ① LCD Display                | ② DC 12V~30V Charging Port    | ③ DC 32V~150V Charging Port |
| ④ AC TT30-R Output           | ⑤ AC 100V~120V Output         | ⑥ Overcurrent Protection    |
| ⑦ RJ45 Signal Sync Interface | ⑧ External Grounding Port     | ⑨ AC 100V~120V Input        |
| ⑩ Wireless Charger           | ⑪ DC 12V/USB/ Wireless Switch | ⑫ AC 100V~120V Switch       |
| ⑬ DC12V XT60 Output          | ⑭ DC12V Auxiliary Output      | ⑮ DC12V(5525)Output         |
| ⑯ USB-A/USB-C Ports          | ⑰ Battery Expansion Port      |                             |

# SPECIFICATIONS

## GENERAL INFO

 Capacity	3072Wh(51.2V60Ah)	 Temperature	0°C~45°C/32°F~113°F (Charging) -20°C~-45°C/-4°F~113°F (Discharging)
 Battery Type	LiFePO4 (3500+Cycles to 80%)	 Dimension	L17.5*W12.1*H13.8 in L445*W307*H350 mm
 Net Weight	Around 79lb Around 36Kg		

## DC OUTPUT

 USB-A *4	(5V,9V,12V,Max 18W)*4	360W Max
 USB-C *2	(5V,9V,12V,Max 18W)*1 (5V,9V,12V,20V,Max 100W)*1	
 XT60-F Output *1	DC 12V-30A	
 Cigar Port *1	DC 12V-10A	
 DC 5525 Output *1	DC 12V-5A	
 Wireless Charger *2	15W Max	

## AC OUTPUT

 BS-U20 *4	Pure sine wave 100V~120V Rated 3600W Max
 TT30-R *1	

## AC INPUT



MJ25 (3+2) \*1

100Vac~120Vac 50/60HZ  
3200W Max (Charging cable with 30A)

## DC INPUT



5521 \*1

12V~30V Max 7A Max 150W



XT60-M \*2

32V~150V Max 20A Max 1200W\*2

## EXTRA BATTERY PORT



MJ32 \*2

Cascade with max 4 pieces of EP3000-48V

## HOW TO USE THE E3600 LFP

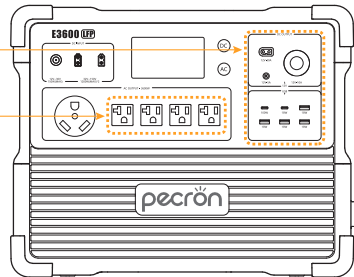

 press and hold to turn on / off DC / USB / Wireless Charger

 press and hold to turn on / off AC

(Please turn off the AC function if there is no AC load on the unit)

# DETAILS AND OPERATING INSTRUCTIONS OF THE DISPLAY

## Display and switch of home page 1

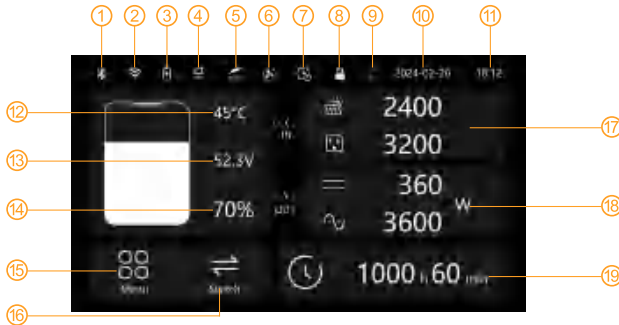

- |  |                    |                             |   |
|--|--------------------|-----------------------------|---|
| ① Bluetooth connection                 | ⑥ FANS ON          | ⑩ Time                      | ⑬ Switch Button                                   |
| ② WIFI connection                      | ⑦ TIMER SWITH ON   | ⑫ Battery Temperature       | ⑭ Display of Input                                |
| ③ Connection of expansion battery pack | ⑧ Touchscreen Lock | ⑬ Battery Voltage           | ⑮ Display of Output                               |
| ④ UPS ON                               | ⑨ Warning          | ⑭ Battery Volume Percentage | ⑯ Remaining Discharge Time /Remaining Charge Time |
| ⑤ ECO ON                               | ⑩ Date             | ⑮ Menu                      |   |

## Display and switch of home page 2

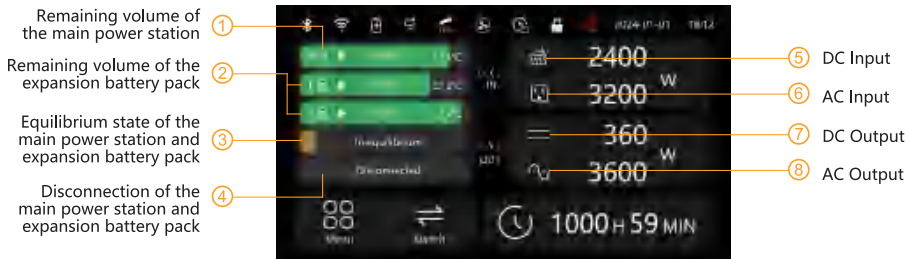

- |  |   |             |  |
|--|---|-------------|--|
| Remaining volume of the main power station                             | ① |             |  |
| Remaining volume of the expansion battery pack                         | ② |             |  |
| Equilibrium state of the main power station and expansion battery pack | ③ |             |  |
| Disconnection of the main power station and expansion battery pack     | ④ |             |  |
|  |   | ⑤ DC Input  |  |
|  |   | ⑥ AC Input  |  |
|  |   | ⑦ DC Output |  |
|  |   | ⑧ AC Output |  |

# HOW TO SET THE TIME AND LANGUAGE OF THE SCREEN ?

Click "Menu" showed as **(Picture 1)**.

Then click "System Setting" showed as **(Picture 2)**.



**(Picture 1)**

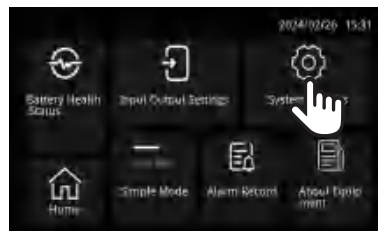

**(Picture 2)**

1: Page up/down by clicking "▲"/"▼" on the left side.

2: Click "Time setting" to adjust the time showed as **(Picture 3)**.



**(Picture 3)**

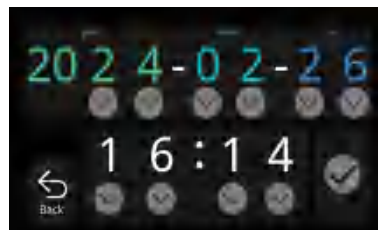

3: Click "Language" to adjust language type. Showed as **(Picture 4)**.



**(Picture 4)**

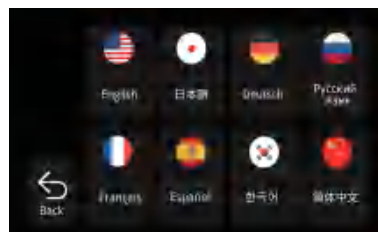

## HOW TO CONNECT WITH APP ?

Click "Menu" showed as **(Picture 1)**.

Then click "System Setting" showed as **(Picture 2)**.



**(Picture 1)**



**(Picture 2)**

1: Click "WIFI reset" showed as **(Picture 5)**.

2: Click "✓" to reset the WIFI and enter the pairing mode showed as **(Picture 6)**.

And then search the device model through the near field on the APP.

If you connect to the APP via WIFI successfully, the WIFI symbol will be displayed.

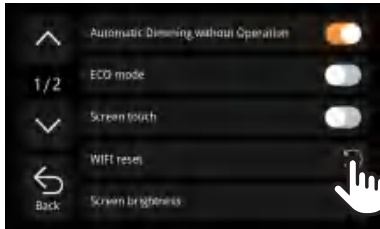

**(Picture 5)**

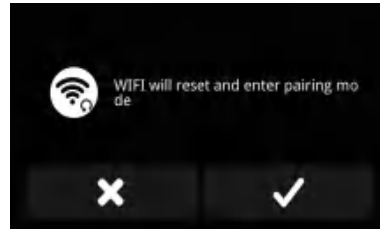

**(Picture 6)**

# HOW TO OPERATE THE SETTING OF INPUT AND OUTPUT ?

Click "Menu" showed as **(Picture 1)**.

Then click "Input Output Settings" showed as **(Picture 7)**.



(Picture 1)



(Picture 7)

Click each option to make the corresponding settings showed as **(Picture 8)**.

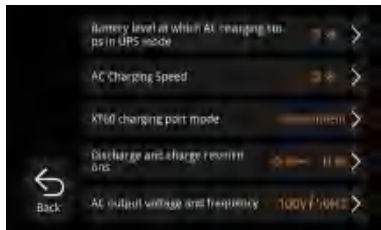

(Picture 8)



# PACKING LIST

## Standard Product List

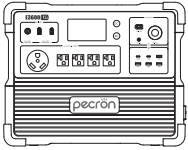

PECRON E3600 LFP \*1



15A AC cable \*1



Single port XT60 to  
MC4 solar charging cable \*1



Parallel dual port XT60 to  
MC4 solar charging cable \*1

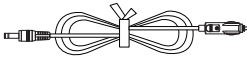

Car Charging Cable \*1



Slotted Screwdriver \*1



Accessory Pouch \*1

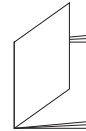

User Instruction \*1

## Optional product accessory

(\* The following accessories are not included in the standard package and can be purchased separately from PECRON)

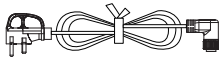

30A AC cable \*1

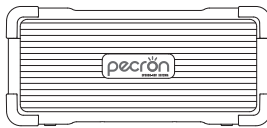

EP3000-48V

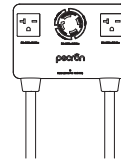

Completed set for  
series connection to 240V

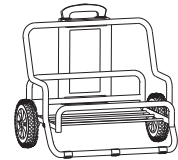

T2 Trolley

## UPS FUNCTION

The E3600 LFP supports UPS function. It can provide the loads(such as computers, data centers, telecommunication equipment) near-instantaneous(within 8~20ms) protection from unexpected power interruptions of the main power supply.

**Note: Not applicable to specific applications that need transfer time under 8ms, such as servers and workstations. This UPS function only support protection for loads under 3600W(120V), we recommend that you only connect one device at a time to avoid overload and thus result in protection failure.**

PECRON is not responsible for any devices damage or loss of data resulting from failing to follow the instructions.

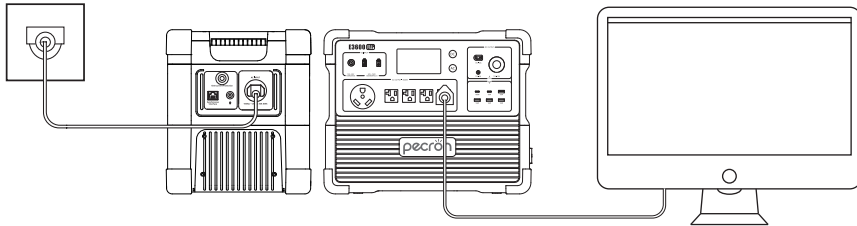

## EXPANDABLE BATTERY

Please use the official cascading cable with MJ32 socket when you want to connect with 4 pcs of expansion battery pack (EP3000-48V) to avoid damage of the power station.

**Notes about cascade:**

- 1: Cascading will be faster if there is only 10% difference between the main power station and the expansion battery pack.
- 2: Before cascading, please make sure the number of knob on the battery pack is unique. The number should be adjusted to 0,1,2,3 according to the number of packs. If the number is wrong, the parameters of the packs will not be shown on the display of the main power station.

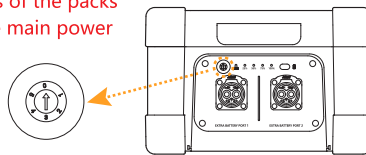

EP3000-48V

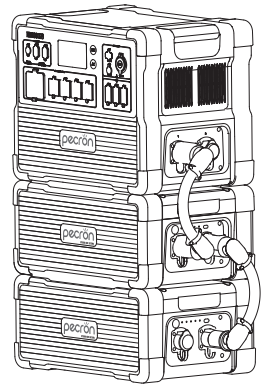

## HOW TO CHARGE THE E3600 LFP BY AC ?

A 15A cable will come together with the power station as standard accessories.  
The type of the cable will be automatically detected by the power station.

When you charge the power station with a 15A cable.

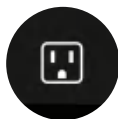
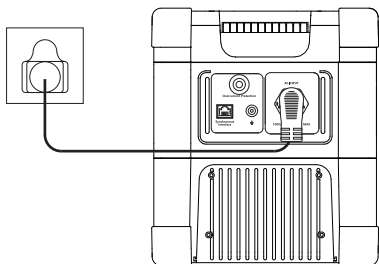

When you charge the power station with a 30A cable.

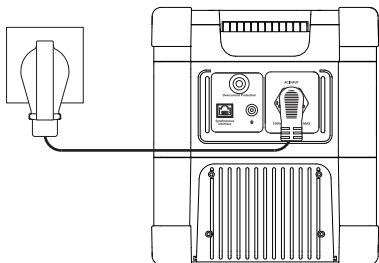

## HOW TO CHARGE THE E3600 LFP BY VEHICLE ?

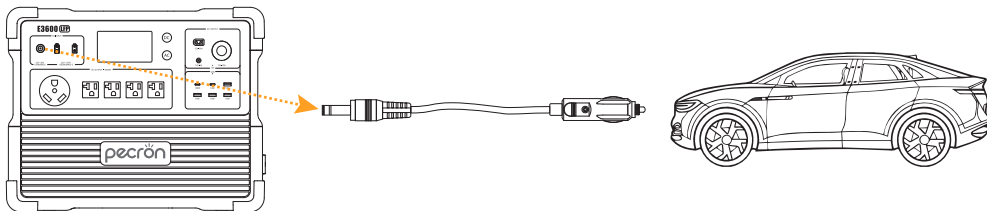

## USING SOLAR PANELS TO CHARGE THE E3600 LFP

- 1. DC5521 Charging Port:** PV/DC 12V~30V, 150W maximum; VOC(open circuit voltage) of solar panel must be less than 30V;
- 2. XT60-M Charging Port:** PV(operating voltage) range 32V~150V, 2400W maximum; VOC(open circuit voltage) of solar panel/array must be less than 150V, otherwise, it will damage the unit! **Do not wire more than three 36V solar panels in series, or more than six 18V solar panels in series.** (18V/36V stands for Vmp of the solar panel)
- 3. If you have any questions, feel free to contact us: [support@pecron.com](mailto:support@pecron.com)**

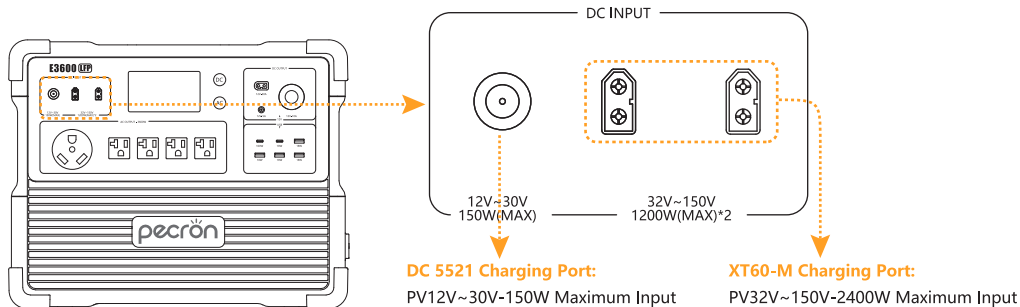

# USING SOLAR PANELS TO CHARGE THE E3600 LFP

## Charging the E3600 LFP with one solar panel

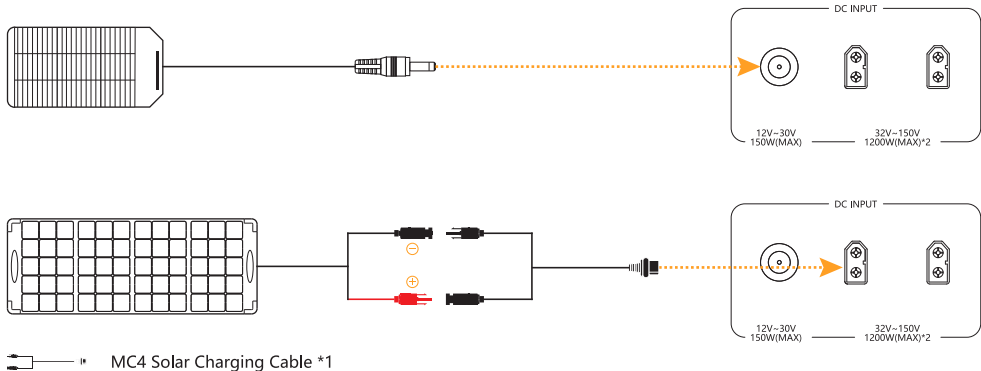

※ It is recommended to choose PECRON solar panels for optimal user experience! The VOC of a single solar panel should be less than 150V, and the VMP should be greater than 32V.

## Use two solar panels in series to charge the E3600 LFP

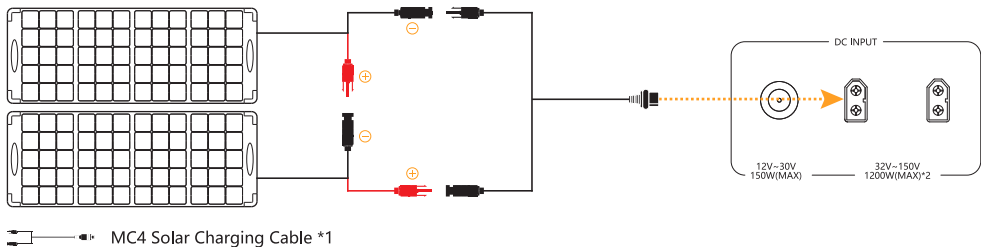

※ It is recommended to choose PECRON solar panels for optimal user experience! The VOC of a single solar panel should be less than 75V, and the VMP should be greater than 16V.

**Use three solar panels in series to charge the E3600 LFP  
(It is recommended to use solar panels with same specifications for optimal power.)**

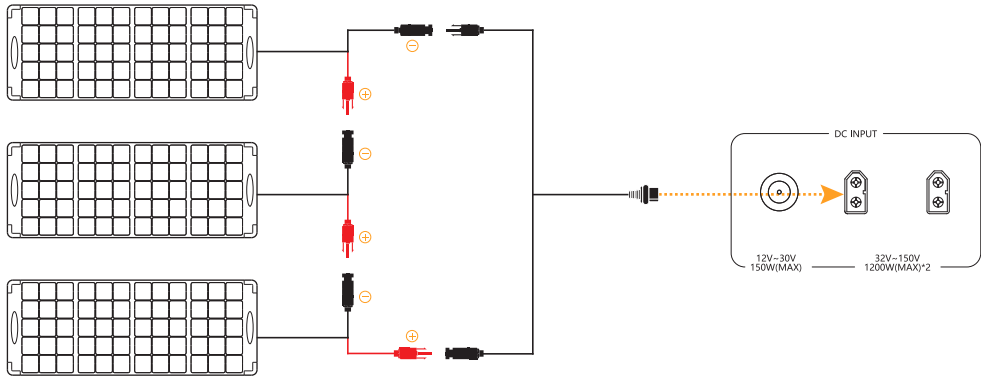

MC4 Solar Charging Cable \*1

⚡ It is recommended to choose PECRON solar panels for optimal user experience! The VOC of a single solar panel should be less than 50V, and the VMP should be greater than 11V.

**Use four solar panels in parallel to charge the E3600 LFP  
(It is recommended to use solar panels with same specifications for optimal power.)**

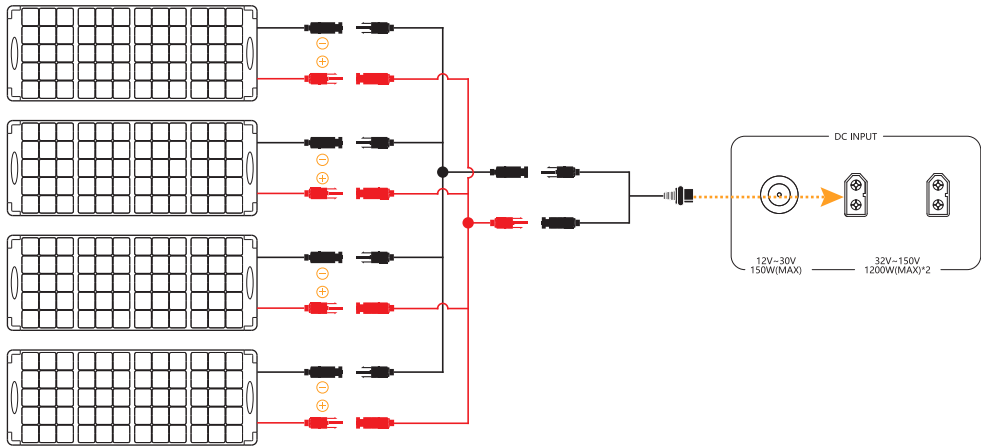

- MC4 Solar Charging Cable \*1
- Y Branch MC4 Charging Cable(+)\*1
- Y Branch MC4 Charging Cable(-)\*1

(NOTE: This parallel charging cable sold separately)

※ It is recommended to choose PECRON solar panels for optimal user experience! The VOC of a single solar panel should be less than 150V, and the VMP should be greater than 32V.

# DO NOT WIRE FOUR SOLAR PANELS IN SERIES!

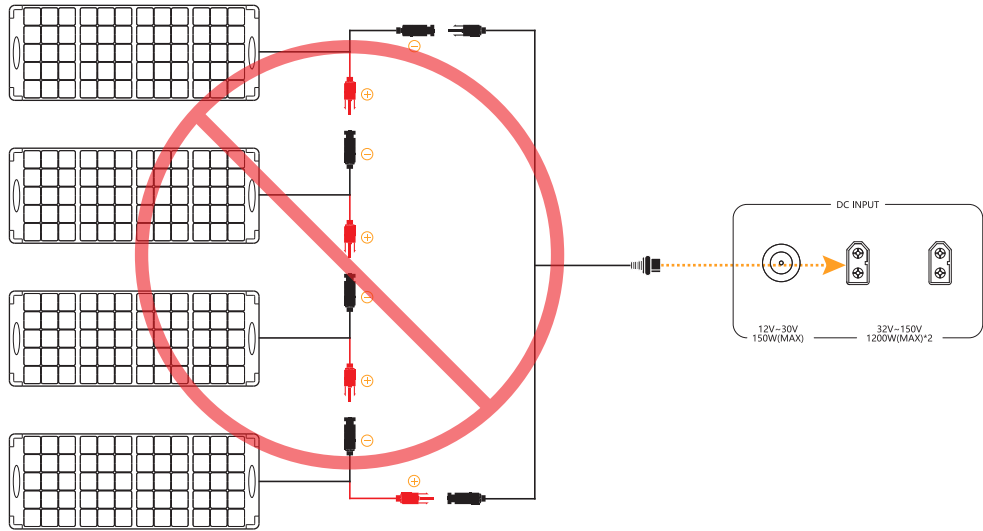

※ PV(XT60) Port Only work within 32V~150V Open Circuit voltage, exceeding 150V will damage the machine.

## FAQS

Q1: What kind of battery is used in E3600 LFP? How long it can last?

A: E3600 LFP utilizes high quality UL certified automotive LiFePO4 battery, it can retain 80% of its original capacity at 3500 complete charge cycles.

Q2: What devices can E3600 LFP power?

A: Please note that the AC output port can only charge or power devices that operate at less than 3600W. DC output port can only charge or power that operate at less than 12V-30A.



Q3: Can the E3600 LFP be used as UPS?

A: E3600 LFP supports UPS function with an automatic switchover time of 8~20ms.

Q4: Can the E3600 LFP be charged while discharging?

A: Yes, E3600 LFP can run devices while it is being charged. The battery will eventually run out if the discharging is greater than the charging during the pass through charging.

Q5: How to calculate the E3600 LFP running time?

A: Running Time=Total Capacity(3072Wh) \* 0.85(Depth of Discharge)/Loading Power(Watts)

Q6: Can I use the E3600 LFP indoors and charge the E3600 LFP indoors?

A: Yes, the E3600 LFP is safe to use indoors.

Q7: Does E3600 LFP have built-in MPPT charge controller?

A: Yes, there are two independent 1200W(PV 32V-150V) MPPT charge controllers inside, and one step up 150W (PV 12V~30V) MPPT charge controller, The Voc ( Open Circuit Voltage) of the solar panels should not exceed 150V.

Q8: How to store the E3600 LFP?

A: Please turn off the unit and then store it in a dry, ventilated place at normal room temperature. Do not place this unit near water sources or a wet/moist environment. For long-term storage, it is recommended to discharge the battery to 30% every three months and recharge it to 60% to sustain the battery life.

## DISCLAIMER

Please read the user manual thoroughly before using this product, and keep this manual in a safe place for future reference. Failure to follow the instructions for proper set up, use, and care for the device can increase the risk of serious personal injury, death, or property damage. Once you use this device, you are deemed to have understood, recognized and accepted all terms and contents of this document. The user shall be responsible for his own actions and all consequences arising from failure to use the device in accordance with the "User Manual" , or as authorized in PECRON's current product literature.

In compliance with laws and regulations, PECRON reserves all rights for final explanation, and to change these terms and conditions at any time without prior notice. In the event that any revisions are made, the revised terms and conditions shall be posted on our website immediately, please visit our website to inform yourself of any changes.

## WARNING

- 1、 Do not place the device near heat source, such as a fire or a heating furnace.
- 2、 Do not immerse in any liquid, or expose the unit to rain or wet conditions.
- 3、 Do not use the battery in a strong static electricity or electromagnetic environment.
- 4、 Do not disassemble or puncture the product with sharp objects in any way.

5. Short circuits can be caused by: vermin or pests chewing through wires; water or other fluids coming into contact with electrical wiring.
6. It's prohibited to be used as car jump starter, only can be used to charge the car battery.
7. Do not use accessories or parts other than those provided by PECRON. Please visit our website [www.pecron.com](http://www.pecron.com) or reach our support team for a complete list of accessories and parts.
8. When using this product, please strictly follow the ambient temperature for use in the user manual. If the temperature is too high, the battery can potentially result in self-combustion and will burst into flames, which can cause widespread damage. If the temperature is too low, the performance of the battery will be seriously degraded, and it may even fail to meet the normal use requirements.
9. Do not stack heavy objects on this product.
10. Do not block the air vents during use, or leave the device in a non-ventilated or dusty space.
11. Please avoid impacts, fall off, and violent vibration. Please turn off the device immediately and stop using it in the event of major exterior impact. Please fasten the unit firmly during transportation to avoid vibration and impact.
12. In the event of immersing the device into the water accidentally, please place the unit in a safe open area and keep away from the unit until it is completely dry. The dried unit should not be reused and should be disposed of properly according to the local regulation. If the device catches fire, use the fire extinguishing equipment in the following recommended order: water or mist, sand, fire blanket, dry chemical, carbon dioxide fire extinguisher.
13. Please wipe it with a dry cloth to clean the surface of the device.
14. Please place this device with care to prevent the product from being damaged due to fall off. If the product is damaged due to fall off, please turn off the unit immediately and place it in an open area, keep away from combustibles and crowds, and dispose of in accordance with local laws and regulations.
15. Please store this device in a place out of reach of children and pets.

## DISPOSAL

1. When conditions permit, please be sure to completely discharge the battery of this product, and then put the product in the designated battery recycling box. This product contains batteries. Batteries are dangerous chemicals and are strictly prohibited from being disposed of in ordinary trash. For details, please follow local laws and regulations on battery recycling and disposal.
2. If the battery cannot be completely discharged due to the failure of the product itself, please do not dispose of the battery directly in the battery recycling box, and contact a professional battery recycling company for further disposal.
3. The battery will not be able to start after being over-discharged, please dispose of it according to the principle of disposal.

## EXCLUSIONS

PECRON' s warranty does not apply to:

Misused, abused, modified, damaged by accident, or used for anything other than normal consumer use as authorized in PECRON' s current product literature.

**CUSTOMER SUPPORT: [support@pecron.com](mailto:support@pecron.com)**

WEBSITE: [www.pecron.com](http://www.pecron.com)



POWER IT POSSIBLE

[www.pecron.com](http://www.pecron.com)

..... support@pecron.com .....