

pecron

E2400 LFP

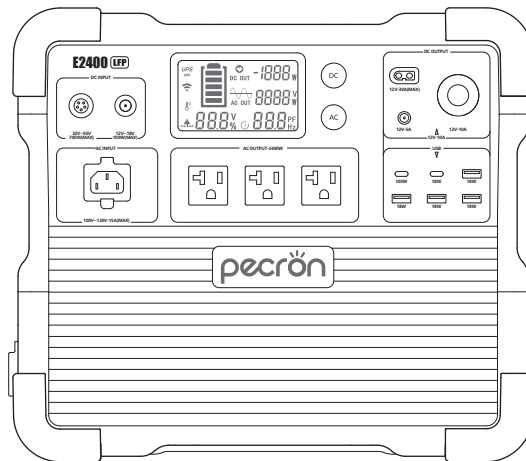

USER MANUAL

Please read the user manual thoroughly before using

support@pecron.com

FUNCTION INTRODUCTION

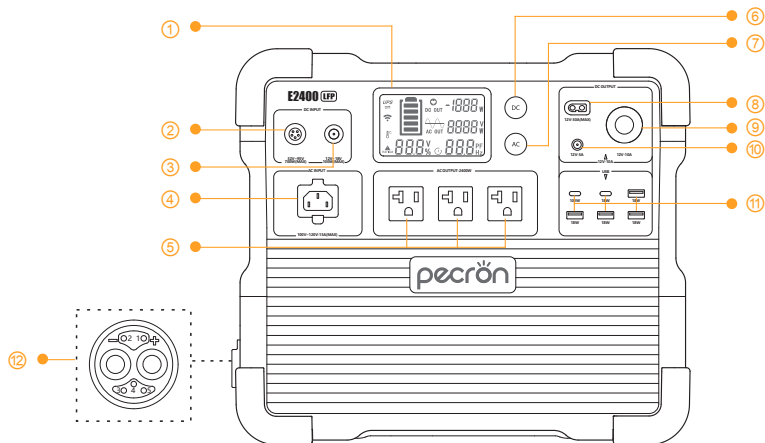

① LCD Display

② DC 32V~95V Charging Port

③ DC 12V~18V Charging Port

④ AC 100V~120V Input

⑤ AC 100V~120V Output

⑥ DC 12V/USB Switch

⑦ AC 100V~120V Switch

⑧ DC12V XT60 Output

⑨ DC12V Auxiliary Output

⑩ DC12V(5525)Output

⑪ USB-A/USB-C Ports





⑫ Battery Expansion Port

SPECIFICATIONS

GENERAL INFO

 Capacity	2048Wh(51.2V40Ah)	 Temperature	0°C~45°C/32°F~113°F (Charging) -20°C~-45°C/-4°F~113°F (Discharging)
 Battery Type	LiFePO4 (3500+Cycles to 80%)	 Dimension	L14.8*W9.3*H13 in L377*W237*H329 mm
 Net Weight	Around 45lb Around 20.5Kg		

DC OUTPUT

 USB-A *4	(5V,9V,12V, 18W Max)*4	360W Max
 USB-C *2	(5V,9V,12V, 18W Max)*1 (5V,9V,12V,20V, 100W Max)*1	
 XT60-F Output *1	DC 12V-30A	
 Cigar Port *1	DC 12V-10A	
 DC 5525 Output *1	DC 12V-5A	

AC OUTPUT

 BS-U20 *3	Pure sine wave 100V~120V Rated 2400W Max
---	---

AC INPUT



AC INLET *1

100Vac - 1500W Max
110Vac - 1650W Max
120Vac - 1800W Max

DC INPUT



GX16MF *1

32V~95V 700W Max 15A Max



5521 *1

12V~18V 100W Max 7A Max

EXTRA BATTERY PORT



MJ32 *1

Cascade with max 2 pieces of EP3000-48V

HOW TO USE THE E2400 LFP

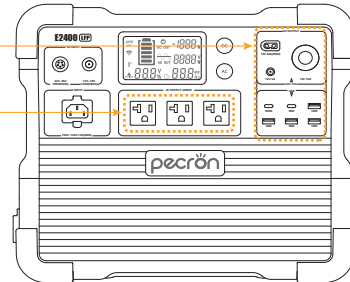
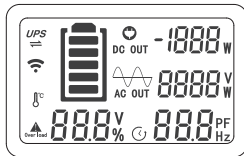

press and hold to turn on / off DC / USB

press and hold to turn on / off AC

(Please turn off the AC function if there is no AC load on the unit)

LCD SMART DISPLAY

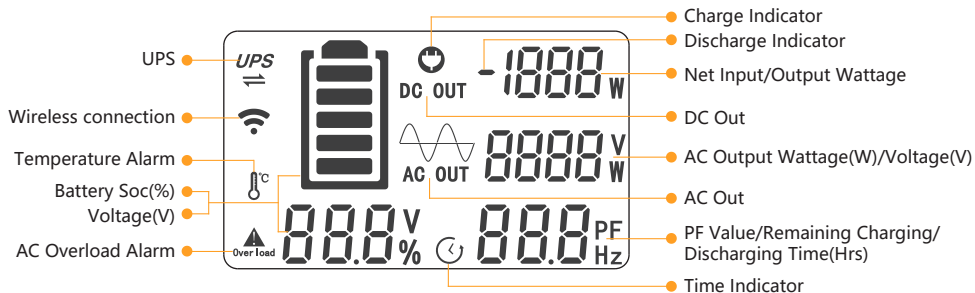

Temperature Alarm Icon

The operating temperature range of E2400 LFP is -20~45°C. If it outputs high power in a hot conditions for a long time, the high temperature alarm icon will flash, indicating that the inverter is overheated, and the AC output will be turned off.



AC Overload Alarm Icon

E2400 LFP can power most devices with power consumption less than 2400 watts. If your devices exceed 2400W, The AC overload alarm indicator will flash, The unit will stop supplying power.



UPS function prompt

When the power station has AC input and the AC output is turned on, the UPS will be turned on, and the UPS icon will always be on to remind.



Wireless function prompt

When the power station is connected to the network via WIFI, this icon will be always on to indicate.

PACKING LIST

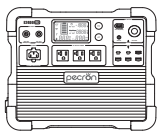

PECRON E2400 LFP *1



AC Charging Cable*1



MC4 Solar Charging
Cable(LSMC4-5GX16)*1



Car Charging Cable *1

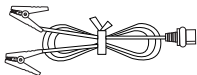

12V Alligator Clips *1



Accessory Pouch *1

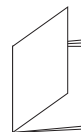

User Instruction *1

UPS FUNCTION

The E2400 LFP supports UPS function. It can provide the loads(such as computers, data centers, telecommunication equipment) near-instantaneous(within 8~20ms) protection from unexpected power interruptions of the main power supply.

Note: Not applicable to specific applications that need transfer time under 8ms, such as servers and workstations. This UPS function only support protection for loads under 1800W(120V), we recommend that you only connect one device at a time to avoid overload and thus result in protection failure.

PECRON is not responsible for any devices damage or loss of data resulting from failing to follow the instructions.

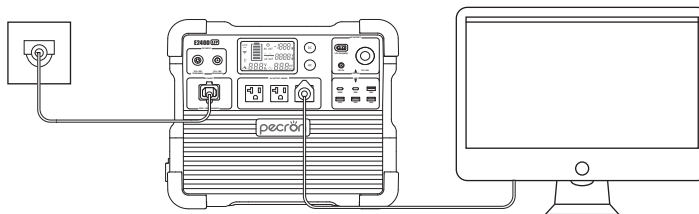

HOW TO ADJUST THE AC OUTPUT FREQUENCY VOLTAGE AND NO-POWER AUTOMATIC SHUTDOWN TIME OF E2400 LFP.

1: After powering on, long press the AC and DC switch at the same time. The battery symbol will flash and then please long press DC to enter into setting.

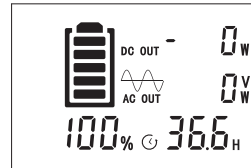

2: Item 001 is for AC output frequency.
Short press DC to set 50Hz or 60Hz.
Then short press AC to next item.

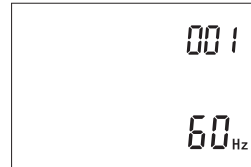

3: Enter setting of 002, this is for AC output voltage.
Short press DC to adjust voltage.
Short press AC again to next setting.

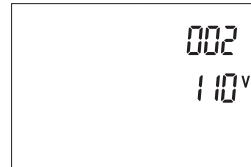

4: Enter setting of 003, the default value is OFF. It means the machine is without any setting about auto shutdown time. Short press DC to set it based on needs and short press AC to enter next step.

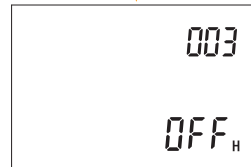

5: Enter setting of 004, it's for WIFI reset. The default is not reset. Short press DC, the screen will show 'RST' which means the reset command is activated.

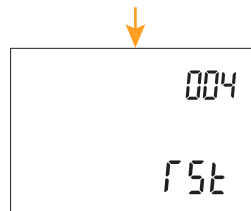

6: Short press AC to finish setting. The display will show EEP when the setting is successful.

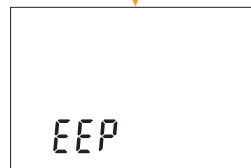

APP FUNCTION

You can connect to this product through the PECRON APP, viewing product information, controlling the device and making personalized settings.

During connection, please long press and hold the DC+AC button together to enter the pairing mode.

iPhone users can search for PECRON in the Apple Store to download and use.

Android users can search for PECRON on Google Play to download and use.

EXPANDABLE BATTERY

Special MJ32 socket can be used to cascade two EP3000-48V plus power packs.

It is strictly forbidden to use non-PECRON plus power pack, otherwise it will damage the power supply!

After cascading the power pack successfully, the display power will show, the percentage of the sum of the host and the power pack.

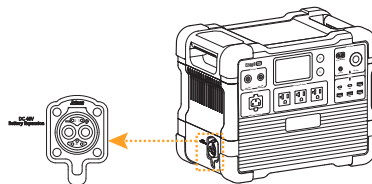

USING SOLAR PANELS TO CHARGE THE E2400 LFP

- DC5521 Charging Port:** PV/DC 12V~18V, 100W maximum; VOC(open circuit voltage) of solar panel must be less than 25V;
- GX16MF-5 Charging Port:** PV(operating voltage) range 32V~95V, 700W maximum; VOC(open circuit voltage) of solar panel/array must be less than 95V, otherwise, it will damage the unit! **Do not wire more than two 36V solar panels in series, or more than four 18V solar panels in series.**
(18V/36V stands for V_{mp} , the operating voltage, of the solar panel)
- If you have any questions, feel free to contact us: support@pecron.com**

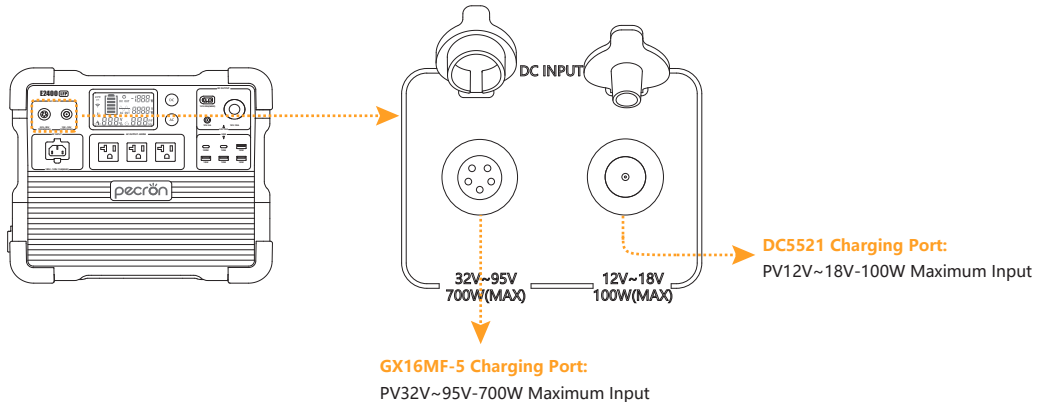

USING SOLAR PANELS TO CHARGE THE E2400 LFP

Charging the E2400 LFP with one solar panel

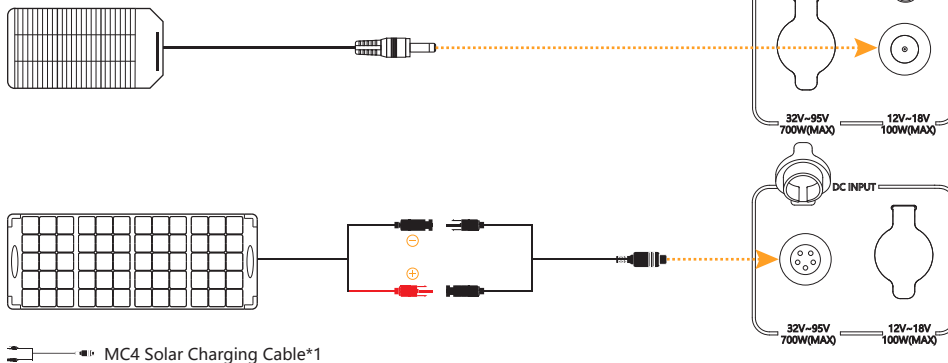

MC4 Solar Charging Cable*1

✘ It is recommended to choose PECRON solar panels for optimal user experience! The VOC of a single solar panel should be less than 95V, and the VMP should be greater than 32V.

Use two solar panels in series to charge the E2400 LFP

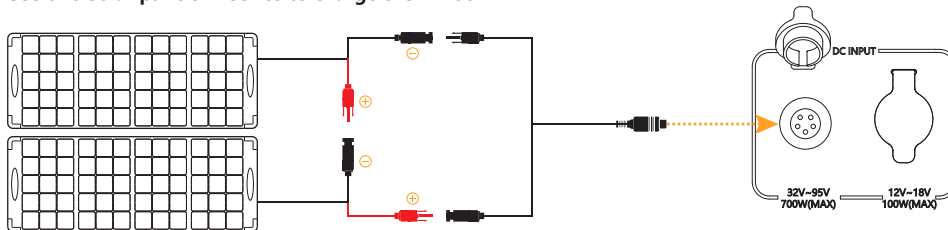

MC4 Solar Charging Cable*1

✘ It is recommended to choose PECRON solar panels for optimal user experience! The VOC of a single solar panel should be less than 48V, and the VMP should be greater than 16V.

USING SOLAR PANELS TO CHARGE THE E2400 LFP

Use three solar panels in parallel to charge the E2400 LFP

(Recommended to use solar panels of the same specification model to obtain the best power.)

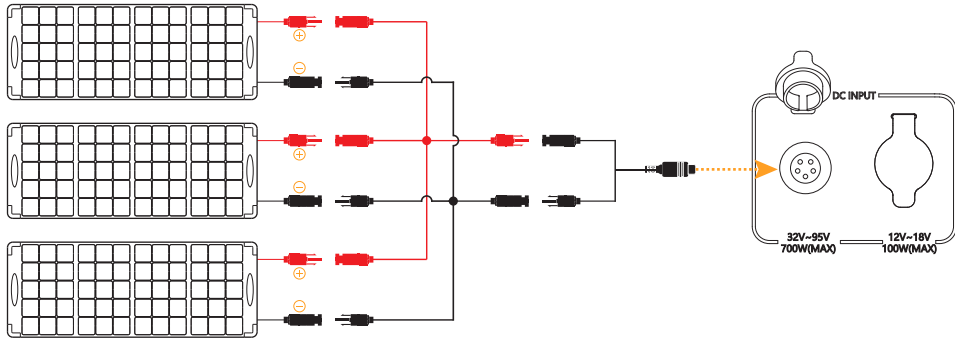

MC4 Solar Charging Cable*1

Y Branch MC4 Charging Cable(+)*1

Y Branch MC4 Charging Cable(-)*1

(NOTE: This parallel charging cable sold separately)

⚠ It is recommended to choose PECRON solar panels for optimal user experience! The VOC of a single solar panel should be less than 95V, and the VMP should be greater than 32V.

DO NOT WIRE THREE SOLAR PANELS IN SERIES!

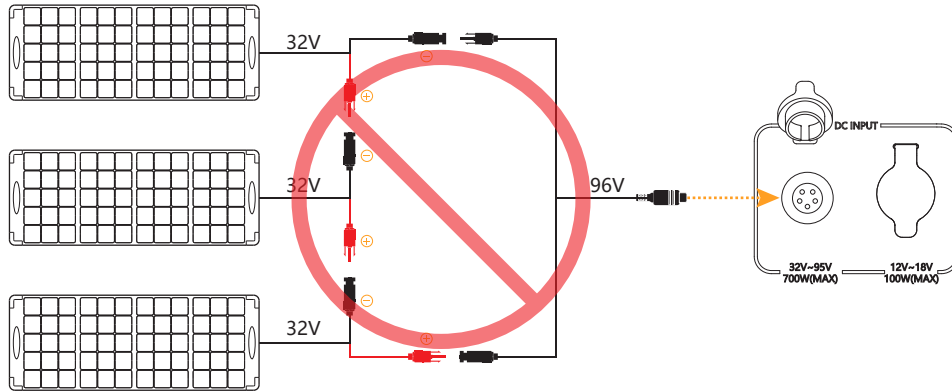

※ PV(GX16MF-5) Port Only work within 32V~95V Open Circuit voltage,exceeding 95V will damage the machine.

FAQS

Q1: What kind of battery is used in E2400 LFP? How long it can last?

A: E2400 LFP utilizes high quality UL certified automotive LiFePO4 battery, it can retain 80% of its original capacity at 3500 complete charge cycles.

Q2: What devices can E2400 LFP power?

A: Please note that the AC output port can only charge or power devices that operate at less than 2400W. DC output port can only charge or power that operate at less than 12V-30A.

Q3: Can the E2400 LFP be used as UPS?

A: E2400 LFP supports UPS function with an automatic switchover time of 8~20ms.

Q4: How to calculate the E2400 LFP running time?

A: Running Time=Total Capacity(2048Wh) * 0.85(Depth of Discharge)/Loading Power(Watts)

Q5: Does E2400 LFP have built-in MPPT charge controller?

A: Yes, there are two independent built-in MPPT charge controllers; "5521" port supports 12~18V(Max 100W) PV input, and "GX16MF" port supports 32~95V(Max 700W) PV input.

Q6: Can the E2400 LFP be charged while discharging?

A: Yes, It can be charged and discharged at the same time. In the non-UPS state, if uninterrupted use is required, the average power of charging must be greater than the average power of electricity, otherwise the battery will eventually run out and shut down.

Q7: How to store the E2400 LFP?

A: Please turn off the unit and then store it in a dry, ventilated place at normal room temperature. Do not place this unit near water sources or a wet/moist environment. For long-term storage, it is recommended to discharge the battery to 30% every three months and recharge it to 60% to sustain the battery life.

Q8: Other issues to be noted.

A: Pay attention to the ponit that the product is without waterproof function and prevent water getting into it. Pay attention to ventilation and heat dissipation when using, and keep good ventilation at the air inlet and outlet of the product.

Do not use the product in special occasions (under the mine, gas station, etc.)

DISCLAIMER

Please read the user manual thoroughly before using this product, and keep this manual in a safe place for future reference. Failure to follow the instructions for proper set up, use, and care for the device can increase the risk of serious personal injury, death, or property damage. Once you use this device, you are deemed to have understood, recognized and accepted all terms and contents of this document. The user shall be responsible for his own actions and all consequences arising from failure to use the device in accordance with the "User Manual" , or as authorized in PECRON's current product literature.

In compliance with laws and regulations, PECRON reserves all rights for final explanation, and to change these terms and conditions at any time without prior notice. In the event that any revisions are made, the revised terms and conditions shall be posted on our website immediately, please visit our website to inform yourself of any changes.

WARNING

- 1、 Do not place the device near heat source, such as a fire or a heating furnace.
- 2、 Do not immerse in any liquid, or expose the unit to rain or wet conditions.
- 3、 Do not use the battery in a strong static electricity or electromagnetic environment.
- 4、 Do not disassemble or puncture the product with sharp objects in any way.
- 5、 Short circuits can be caused by: vermin or pests chewing through wires; water or other fluids coming into contact with electrical wiring.
- 6、 It's prohibited to be used as car jump starter, only can be used to charge the car battery.
- 7、 Do not use accessories or parts other than those provided by PECRON. Please visit our website www.pecron.com or reach our support team for a complete list of accessories and parts.
- 8、 When using this product, please strictly follow the ambient temperature for use in the user manual. If the temperature is too high, the battery can potentially result in self-combustion and will burst into flames, which can cause widespread damage. If the temperature is too low, the performance of the battery will be seriously degraded, and it may even fail to meet the normal use requirements.
- 9、 Do not stack heavy objects on this product.
- 10、 Do not block the air vents during use, or leave the device in a non-ventilated or dusty space.
- 11、 Please avoid impacts, fall off, and violent vibration. Please turn off the device immediately and stop using it in the event of major exterior impact. Please fasten the unit firmly during transportation to avoid vibration and impact.

- 12、 In the event of immersing the device into the water accident, please place the unit in a safe open area and keep away from the unit until it is completely dry. The dried unit should not be reused and should be disposed of properly according to the local regulation. If the device catches fire, use the fire extinguishing equipment in the following recommended order: water or mist, sand, fire blanket, dry chemical, carbon dioxide fire extinguisher.
- 13、 Please wipe it with a dry cloth to clean the surface of the device.
- 14、 Please place this device with care to prevent the product from being damaged due to fall off. If the product is damaged due to fall off, please turn off the unit immediately and place it in an open area, keep away from combustibles and crowds, and dispose of in accordance with local laws and regulations.
- 15、 Please store this device in a place out of reach of children and pets.

DISPOSAL

- 1、 When conditions permit, please be sure to completely discharge the battery of this product, and then put the product in the designated battery recycling box. This product contains batteries. Batteries are dangerous chemicals and are strictly prohibited from being disposed of in ordinary trash. For details, please follow local laws and regulations on battery recycling and disposal.
- 2、 If the battery cannot be completely discharged due to the failure of the product itself, please do not dispose of the battery directly in the battery recycling box, and contact a professional battery recycling company for further disposal.
- 3、 The battery will not be able to start after being over-discharged, please dispose of it according to the principle of disposal.

EXCLUSIONS

PECRON' s warranty does not apply to:

Misused, abused, modified, damaged by accident, or used for anything other than normal consumer use as authorized in PECRON' s current product literature.

CUSTOMER SUPPORT: support@pecron.com

WEBSITE: www.pecron.com



POWER IT POSSIBLE

www.pecron.com

..... support@pecron.com